

KAY ATTENUATORS

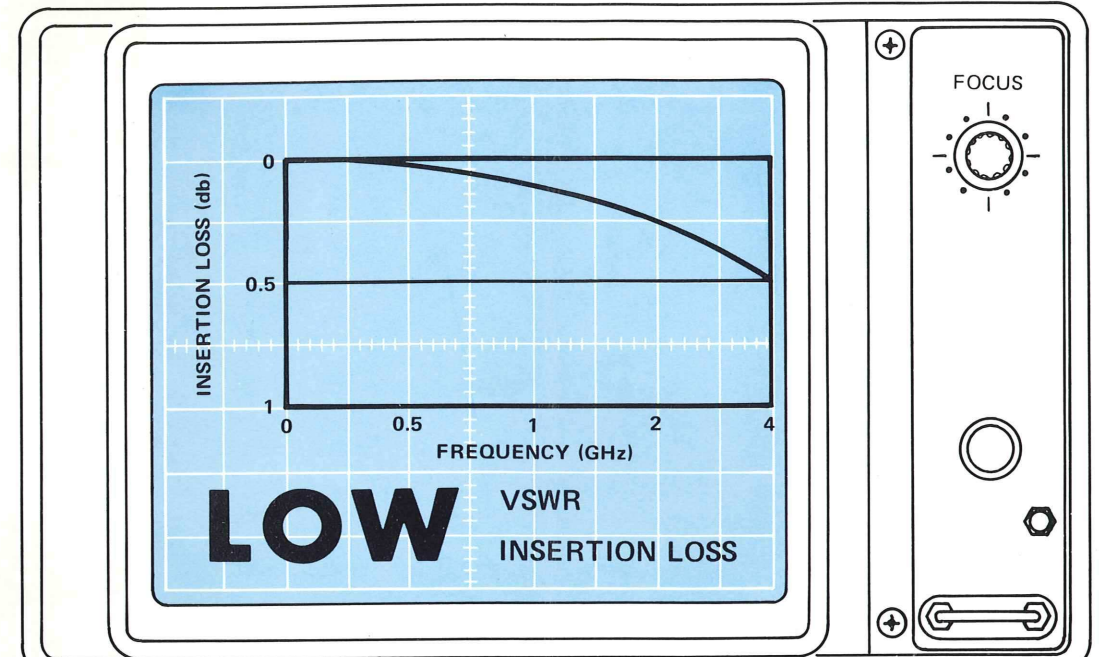

+

FOCUS

+

POSITION

POSITION

MULTIPLIER

SECONDS/DIV

+

KAY Elemetrics Corp

KAY ATTENUATORS

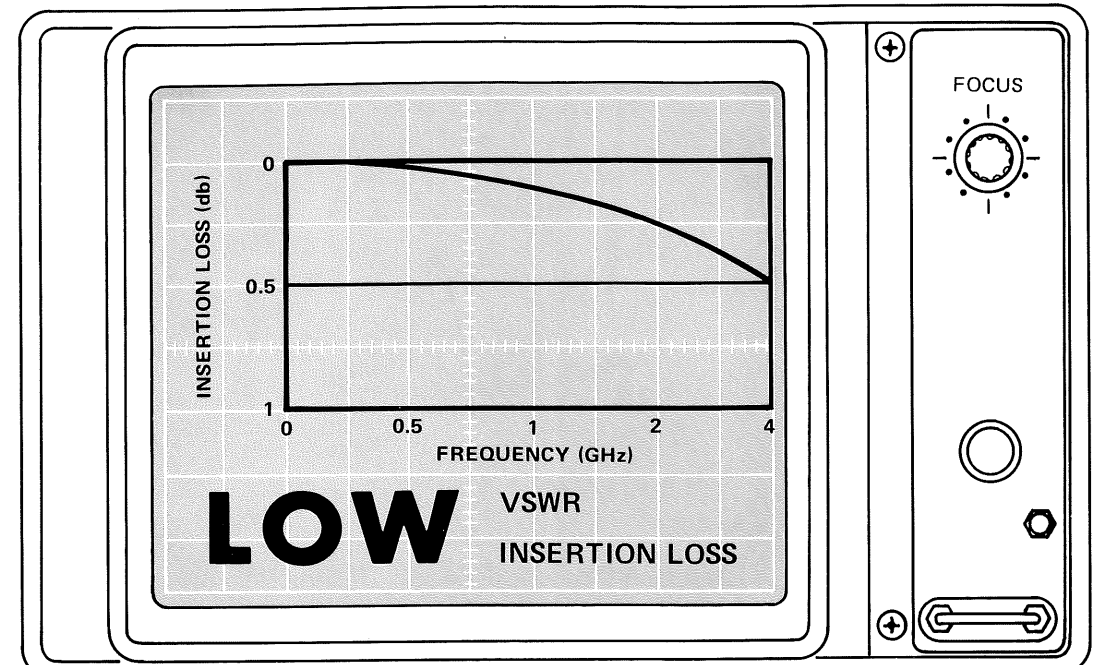





+





FOCUS

+

+

POSITION  POSITION 

MULTIPLIER  SECONDS/DIV 

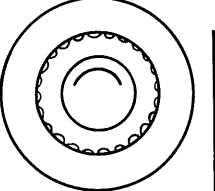
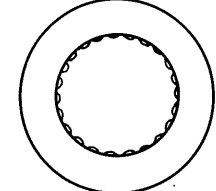



KAY Elemetrics Corp

INSTRUCTION MANUAL

***ATTENUATORS
IN-LINE***

Issue A

March 1976

KAY Elemetrics Corp. Pinebrook, N. J. 201-227-2000

© Kay Elemetrics Corp. 1976

Policy Covering Reproduction And Use of Technical Data

Data contained in this manual is copyrighted by KAY Elemetrics Corp. and is furnished solely for the purpose of providing instructions for operation and maintenance of the apparatus described herein. Said data shall not be used by the purchaser or the government for promotional procurement, development or manufacturing purposes, nor shall the data be reproduced or disclosed without permission from KAY Elemetrics Corp. In the event of resale of the apparatus to the government, by the purchaser, the purchaser shall notify the government of the limited right to use said data.

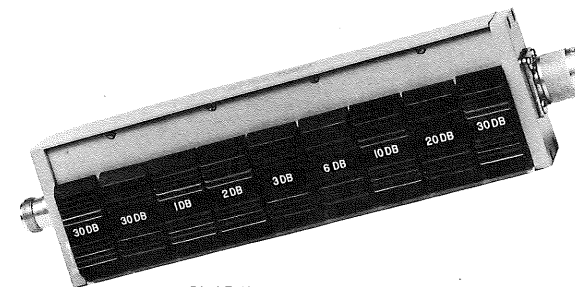

SLIDING BLOCK

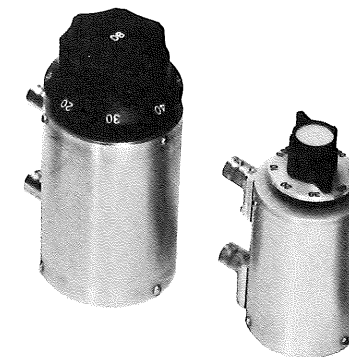

ROTARY

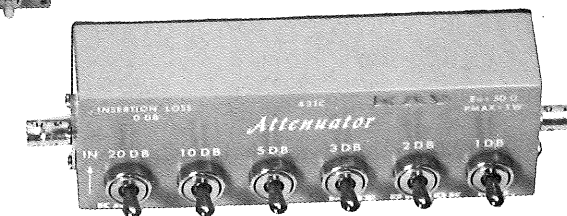
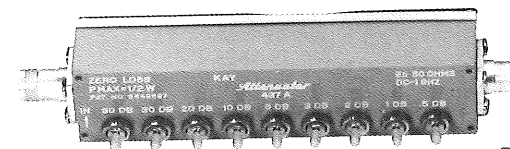
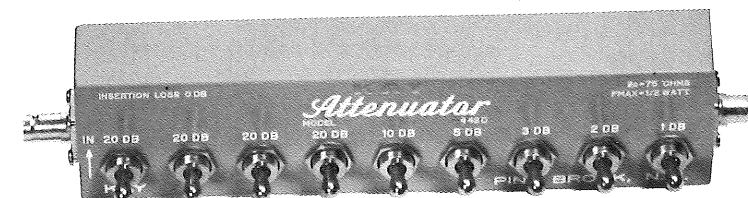

IN-LINE

TABLE OF CONTENTS

SECTION I GENERAL INFORMATION

Section		Page
1.1	Introduction	1-1
1.2	Application	1-1
1.3	Receiving and Reshipment Instructions	1-1
1.4	Operating Instructions	1-1
1.5	Circuit Description	1-3
1.6	Attenuator Modifications	1-4
1.7	Additional Attenuators	1-4
1.8	Associated Equipment	1-4

SECTION II DESCRIPTION AND SPECIFICATION DATA

2.1	Introduction	2-1
2.2	Description	2-1
2.3	Mechanical Assembly Information	2-2
2.4	Specifications	2-5

SECTION III MAINTENANCE

3.1	Introduction	3-1
3.2	Test Procedure	3-1
3.3	Checking Attenuators	3-2

SECTION IV PARTS AND SCHEMATICS

4.1	Introduction	4-1
4.2	Part Identification	4-1
4.3	Schematics	4-2

SECTION I
GENERAL INFORMATION

1.1 INTRODUCTION

Kay Elemetrics attenuators are designed to provide an accurate amount of loss in a circuit operating in the DC to 6 GHz range. Attenuation up to 132 db and increments as small as 0.1 db can be obtained. All models are symmetrical (bi-directional) attenuators.

Three basic attenuator configurations are available. These include in-line toggle switch attenuators, sliding block attenuators for DC thru microwave frequencies, and rotary and rotary-style attenuators. We also produce a line of programmable attenuators which can be controlled by logic level inputs and may be used for automatic testing.

1.2 APPLICATIONS

Kay attenuators may be used wherever it is desired to insert an accurate and variable amount of attenuation. Such applications would include its use as a (1) supplemental attenuator, providing additional attenuation where insufficient attenuation is provided in the original set-up, (2) replacement for inaccurate level controls in the original instrument, (3) general purpose attenuator, for instruments without sufficient or accurate internal attenuation, (4) vernier attenuator, where large increments only are provided, or (5) calibration standards. In addition, some of our attenuator models may be panel mounted for internal use as an integral part of the customer's equipment. Many models may be modified for panel mounting.

1.3 RECEIVING AND RESHIPMENT INSTRUCTIONS

When the attenuator is initially received, a visual check should determine any damage that may have occurred during shipment. The most important things to note are the coaxial connectors and the switch operation. Some rotary attenuators are provided with stops at the extremes of the attenuation range. When checking the switch action of these units, care should be taken to avoid damage.

Should any shipping damage be discovered, please report it immediately to the carrier and to the Kay Elemetrics Corp.

To return an instrument, please obtain permission from the factory or a Kay representative before doing so. To aid the service personnel, include the serial number and the defect on the packing slip.

1.4 OPERATING INSTRUCTIONS

The Kay attenuators described in this manual are operationally very similar and therefore one set of operating instructions will apply to most models. Their use is simple and generally well-known to the majority of people in the electronic measurement field. However, a few precautionary procedures should be kept in mind. A typical inter-connection diagram is included here to acquaint the operator with the use of the attenuator.

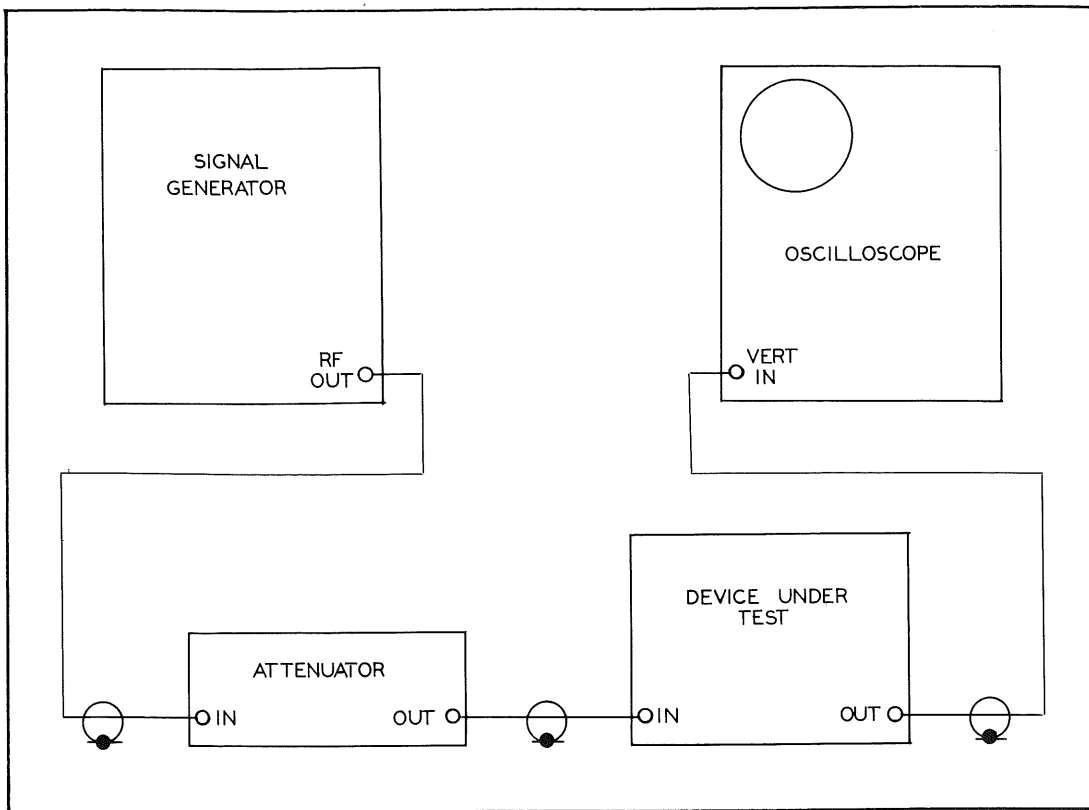

FIG. 1.1 TYPICAL INTERCONNECTION DIAGRAM

1. Impedance mismatch will seriously effect the accuracy of the attenuator. Thus care should be taken to ensure that the signal source, device under test, and inter-connections should all be of the same impedance as the attenuator.
2. The attenuator is not provided with fuses or other protective devices. Thus, in order to avoid damage to the precision resistors, the input signal level to the attenuator must be kept within the maximum power rating of the attenuator. Caution should be exercised when high level DC or AC signals are isolated from the R.F. signals on multiplex systems.
3. Attenuation levels are elected differently in each of the three basic types of attenuators. For the inline attenuators, attenuation levels are selected by placing the switch in the "UP" or "ATTENUATION IN" position. The individual steps are additive. For instance, to obtain a loss of 35 db, the switches for the 20, 10 and 5 db steps are placed in "IN" position.

The attenuators which operate up to 4 GHz or above have sliding block pads. To activate these, the switch must be pressed downward, then moved to the other side of the attenuator. As with the in-line units, the individual steps are additive.

Rotary attenuators are dialed for the proper attenuation. Since the act of rotation moves a complete pad into contact with the connectors, the individual pads are not additive. Some of the rotary units have stops positioned at the high and low end of the dial, so care must be taken not to override these steps or serious damage will result.

1.5 CIRCUIT DESCRIPTION

Although the different types of attenuators described in this book use various mechanical arrangements to accomplish their function, all of them are electrically similar.

Basically, an attenuator is designed to perform one function, that is, to reduce a signal from a high level to a lower one. In the case of low frequency signals, it is usually sufficient to only provide a resistive network to lower the signal. At higher frequencies it is necessary to provide a means of matching impedance between the attenuator and the test device to prevent reflected energy. For this reason, the attenuator is designed with carefully calculated values of resistance, capacitance and inductance so as to offer a balance of attenuation accuracy and impedance match. Most Kay Elemetrics attenuators utilize a "pi" type attenuation network mounted in a broad tuned cavity. This arrangement is designed to meet the requirements of precise attenuation values and proper impedance match.

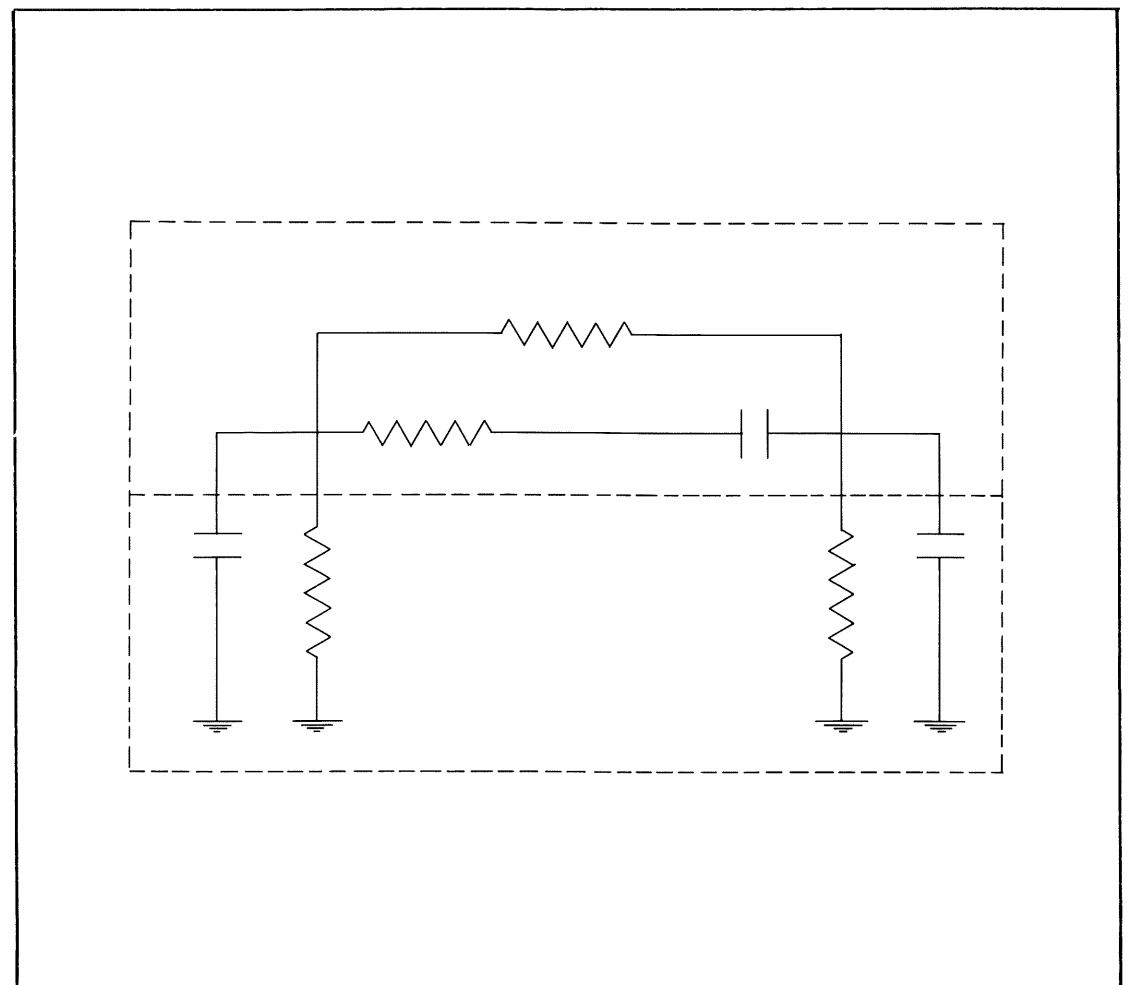

FIG. 1.2 SCHEMATIC OF PI SECTION ATTENUATOR PAD.

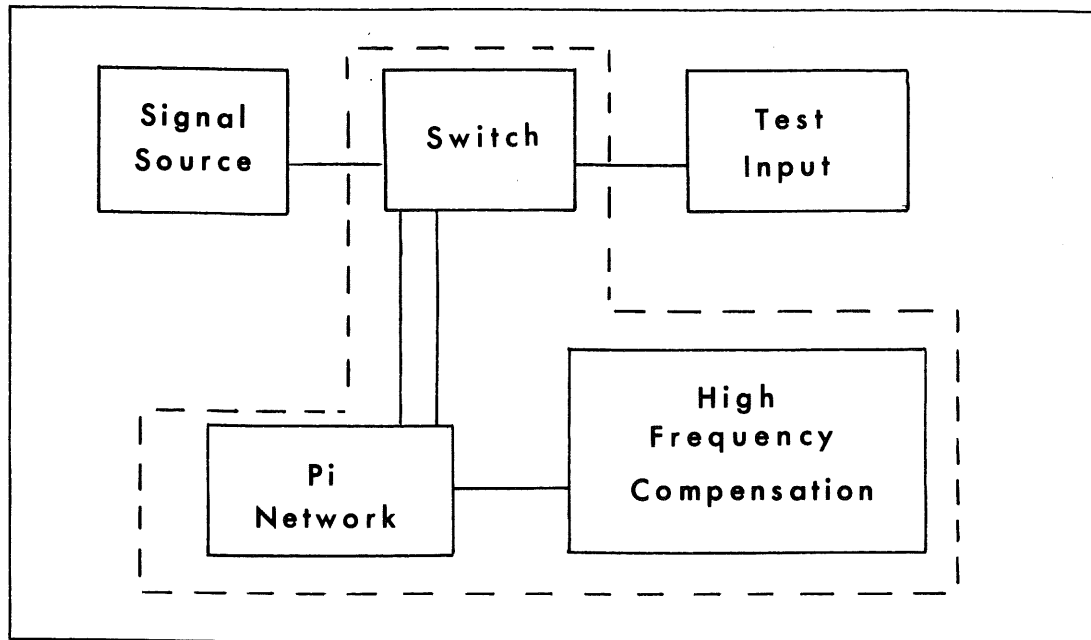

FIG. 1.3 BLOCK DIAGRAM

1.6 ATTENUATOR MODIFICATIONS

Although the selection of Kay attenuators is extensive, we realize that the requirement of the customers are almost endless. For this reason we are willing to work to provide the exact attenuator needed. In fact, some of our standard line of attenuators were originally modifications suggested by and built for a particular customer.

Such things as placement of connectors, type of connectors, attenuation step values, frequency, and attenuation ranges may be modified to suit the needs of the individual customer. Kay has also supplied most of these attenuator models mounted on panels for rack mounting, and cabinets. Most of these modifications are minor and entail only a slight additional charge.

1.7 ADDITIONAL ATTENUATORS

There are Kay attenuators not described in this manual. The 4430 is programmable, controlled by logic level inputs, and well adapted for automatic testing. The O/400 and O/410 attenuators are continuously variable models. Please request our attenuator catalog to obtain more information on these units.

1.8 ASSOCIATED EQUIPMENT

Besides a complete line of attenuators, Kay builds a large and varied assortment of quality measurement instruments, including swept and CW RF signal generation, frequency counters, linear and logarithmic amplifiers, noise figure meters, pulse generators, return loss bridges, matching pads, and detectors. Kay Sweep Generators and return loss bridges are particularly valuable for attenuator checking and servicing. Please write for our complete catalog.

SECTION II DESCRIPTION AND SPECIFICATION DATA IN LINE ATTENUATORS

2.1 INTRODUCTION

These attenuators are assembled in lightweight castings with separate, silver-plated compartments for each step. Individual attenuator sections are connected in series and are additive as the switches are placed in the "IN" position.

In this family of attenuators are included the standard size units, providing attenuations of 0-41 and 0-101 db in 1 db steps and 0-22.1 db in 0.1 db steps. Impedances of 50, 75, and 90 ohms are available in most ranges. A miniature line of these units is also available.

Attenuation levels are controlled by high-frequency toggle switches, constructed of precious metal contacts set in "teflon" for low loss and superior match. Precision, 1% carbon-film resistors are used throughout. The individual pi pads are housed in silver-plated alloy castings which utilize broad-tuned shielded compartments to provide high accuracy and a flat frequency response over the specified range. They have met rigid environmental tests which are traceable to N.B.S.

2.2 DESCRIPTION AND SPECIFICATIONS

Panel Mounting and Connector Configurations

Kay attenuators are panel mounted directly into a wide variety of test equipment and special connector configurations have been developed for those units.

Some models are designed to be mounted as shown in Figure 2.1 with four mounting holes. The attenuator is tapped for an 8-32 by $\frac{3}{8}$ " machine screw centered $\frac{1}{8}$ inch from each edge. Besides the standard configuration, there are three special configurations:

A Position — One connector mounted in the A position as shown on the drawing, and the other connector mounted on the opposite end as in standard units.

B Position — One connector mounted in the B position as shown on the drawing, and the other connector mounted on the opposite end as in standard units.

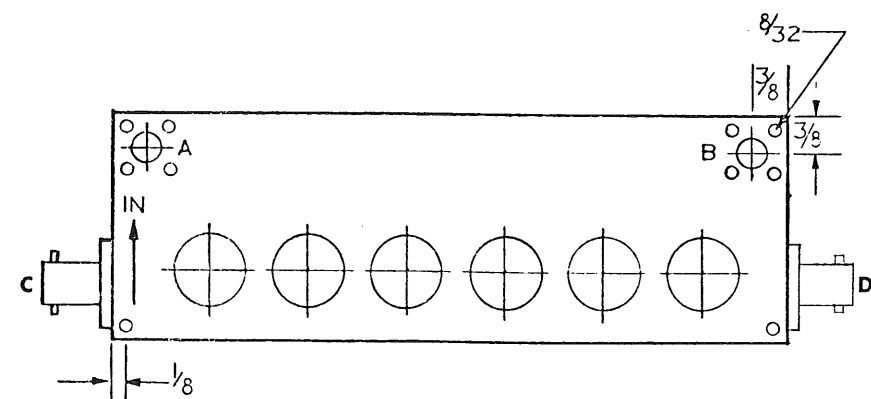

FIG. 2.1 PANEL MOUNTING AND CONNECTOR CONFIGURATION

*Note: 430, 431, 432, 1/432, 441, 442, 1/442, 451, 452, and 1/452 may be obtained with connectors in special positions.

A-B Position — One connector mounted in the A position as shown on the drawing, and the other connector mounted in the B position. No end connectors.

Some of these special model attenuators have the same specifications as the standard units up to 500 MHz and are useful to 1000 MHz. Please see Section 1.4 for additional information on modifications available.

2.3 MECHANICAL ASSEMBLY INFORMATION

This section covers the dis-assembly, re-assembly, and part ordering procedure for the Kay In-Line attenuators.

To perform maintenance work on the attenuator, the back plate must be removed. There are three back plate arrangements, depending on the particular type of attenuator. These arrangements are shown in Chart 2.1. An exploded view of one of the back plate arrangements is shown in Figure 2.2.

Dis-assembly procedure is as follows:

1. Carefully lift adhesive felt backing at all mounting hole locations with the blade of a screw driver.
2. Remove the machine screws securing the back plate. The number of screws will depend upon the attenuator model. The back plate may now be lifted off, and in attenuators having backplate arrangement 1, the components will be exposed.
3. On units with back plate arrangement 3, there is a shield plate located just under the back plate. Remove the two 2-56 flat head machine screws securing this plate and lift it off.
4. Under the shield plate, there is an RF gasketing strip. There is no mechanical attachment for this strip after the plates are removed, but it may still adhere to the attenuator due to pressure of the mounting. Carefully remove this strip. It is somewhat fragile and may tear if handled roughly. All components are now exposed.

Re-assembly is performed by reversing the above procedure. In the shield plate and RF gasketing there are a series of tuning access holes. When re-assembling, these holes must be on the side of the attenuator opposite to that side occupied by the switches. Otherwise, re-assembly is fairly straightforward.

Replacement parts are available from the Kay Elemetrics Corp. To insure accuracy and dependability, identical components are recommended for replacement use. Proper electrical performance will be maintained if components are replaced in the same position and with the lead lengths approximately the same.

When ordering replacement parts, the attenuator model number should be specified together with the part description and schematic reference number or Kay part numbers. Switch modules, including the teflon switch, attenuation resistors, and frequency compensation components, wired and ready for installation, are also available. To order these switch modules, the attenuator catalog number, attenuator impedance, and db-step should be specified.

For your convenience, as well as to aid us in shipping the correct replacement part to you, a parts ordering sheet is included at the rear of this manual.

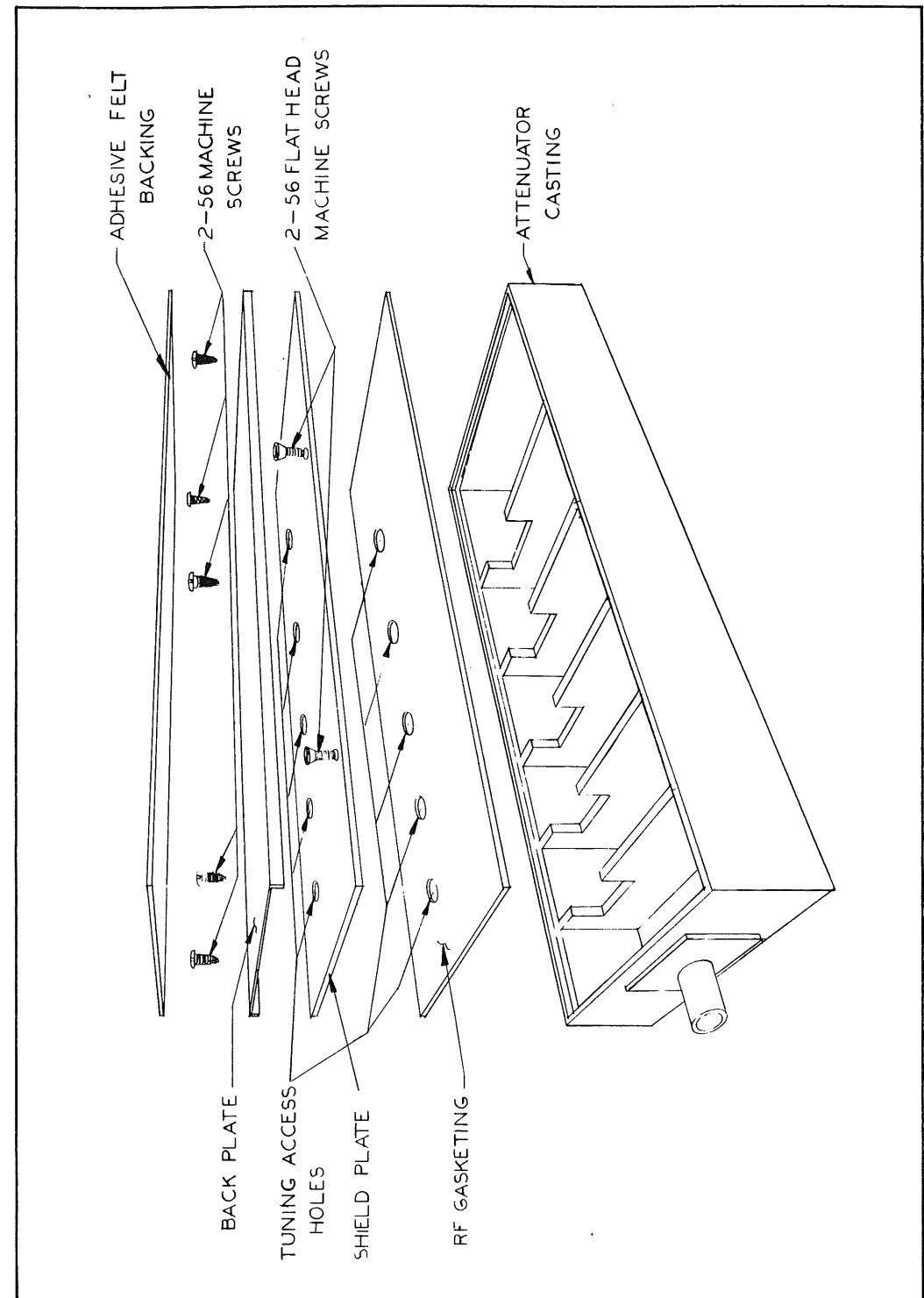

FIG. 2.2 BACK PLATE ARRANGEMENT 3, EXPLODED VIEW

CHART 2.1 BACKPLATE ARRANGEMENTS

ATTENUATOR MODELS	BACKPLATE ARRANGEMENT
430, 431, 432, 1/432 441, 442, 1/442, 451 452, 1/452	Arrangement 1 Adhesive felt backing 1-72 Machine screws * Backplate
438, 439, 448, 449, 1/449	Arrangement 2 Adhesive felt backing 6 2-56 Machine screws Backplate RF gasketing strip.
437, 447, 460, 470	Arrangement 3 Adhesive felt backing 6 2-56 Machine screws Backplate 2 2-56 Flathead machine screws Shield plate RF Gasketing strip
*NOTE: Number of machine screws securing backplate depends on model of attenuator.	

2.4 SPECIFICATIONS

MODELS: 430 431 441 451

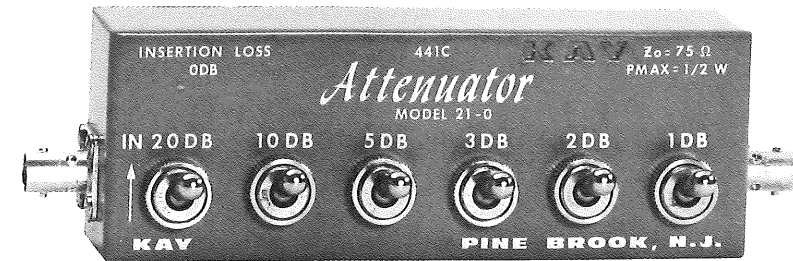

6 STEP IN-LINE 0-41dB in 1dB steps

One of the first Kay attenuators, and still a "workhorse." It provides 41 db in six switched steps (20, 10, 5, 3, 2, 1) available in 50, 75 or 90 ohms.

MODEL NO.	430*	431	441	451
IMPEDANCE (OHMS)	50	50	75	90
FREQ. RANGE	DC - 1GHz	DC - 1GHz	DC - 1GHz	DC - 0.5GHz
ATTENUATION RANGE	51*	41	41	41
ATTENUATION STEPS	1	1	1	1
OVERALL ACCURACY (+-DB)	DC - 250MHz - 0.5dB 250 - 500MHz - 0.9 500 - 1000MHz - 1.2	DC - 250MHz 0.5 dB 250 - 500MHz 0.9 500 - 1000MHz 1.2	DC - 250MHz 0.5 dB 250 - 500MHz 0.9 500 - 1000MHz 1.2	DC - 250MHz 0.5dB 250 - 500MHz 1.2 dB
INSERTION LOSS (DB)	DC - 250MHz - 10.1 250 - 500MHz - 10.2 500 - 1000 - 10.5	DC - 250MHz 0.1 250 - 500MHz 0.2 500 - 1000MHz 0.5	DC - 250MHz 0.1 250 - 500MHz 0.2 500 - 1000MHz 0.4	DC - 250MHz 0.1 250 - 500MHz 0.1
MAXIMUM VSWR	DC - 250MHz 1.2:1 250 - 500MHz 1.4:1 500 - 1000 1.4:1	DC - 250MHz 1.2:1 250 - 500MHz 1.4:1 500 - 1000MHz 1.4:1	DC - 250MHz 1.2:1 250 - 500MHz 1.4:1	DC - 250MHz 1.3:1 250 - 500MHz 1.5:1
POWER (WATTS)	1	1	1	1
CONNECTORS	BNC	BNC	BNC	BNC
CONTROLS	Toggle	Toggle	Toggle	Toggle
DIMENSIONS	2 X7X2 INS.	2X7X2 ins	2X7X2 ins	2X7X2 ins.
WEIGHT	1.5 lbs	1.5 lbs	1.5 lbs	1.5 lbs

MODELS: 432 442 452

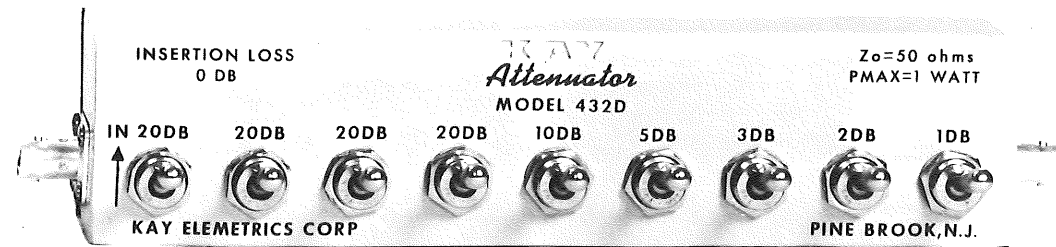

9 STEP IN-LINE

0-101 db in 1 db steps

By increasing the number of switched steps from six to nine, a new series of attenuators were developed, giving a 101 db maximum attenuation in 1 db steps (20,20,20,20,10,5,3,1). These are also available in 50,75, and 90 ohms models.

MODEL NO.	432	442	452
IMPEDANCE (OHMS)	50	75	90
FREQ. RANGE	DC - 1GHz	DC - 1GHz	DC - .5GHz
ATTENUATION RANGE	DC - 101	DC - 101	DC - 101
ATTENUATION STEPS	1	1	1
OVERALL ACCURACY (+-DB)	DC - 250MHz 0.6 250 - 500MHz 1.2 500 - 1000MHz 2.0	DC - 250MHz 1.0 250 - 500MHz 1.2 500 - 1000MHz 2.0	DC - 250MHz 1.0 250 - 500MHz 2.0
INSERTION LOSS (DB)	DC - 250MHz 0.1 250 - 500MHz 0.3 500 - 1000MHz 0.6	DC - 250MHz 0.1 250 - 500MHz 0.2 500 - 1000MHz 0.4	DC - 250MHz 0.1 250 - 500MHz 0.1
MAXIMUM VSWR	DC - 250MHz 1.2:1 250 - 500MHz 1.4:1 500 - 1000MHz 1.4:1	DC - 250MHz 1.2:1 250 - 500MHz 1.2:1 500 - 1000MHz 1.4:1	DC - 250MHz 1.3:1 250 - 500MHz 1.5:1
POWER (WATTS)	1	1	1
CONNECTORS	BNC	BNC	BNC
CONTROLS	Toggle	Toggle	Toggle
DIMENSIONS	2x9½x2 ins.	2x9½x2 ins.	2x9½x2 ins.
WEIGHT	2lbs	2lbs	2lbs

MODELS: 1/432 1/442 1/452

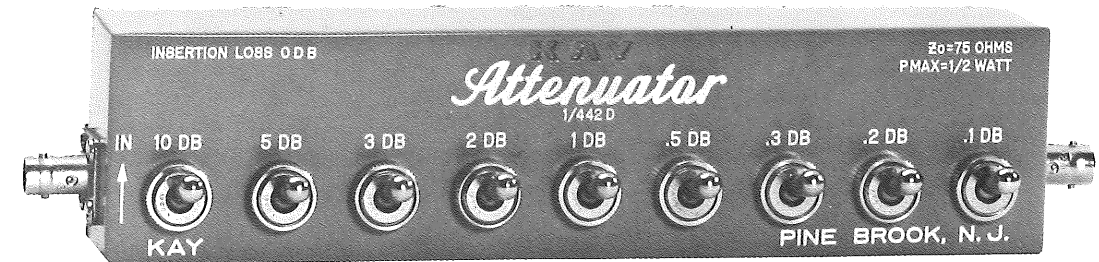

9 STEP IN-LINE

0-22.1 dB in 0.1 dB steps

By replacing some of the standard attenuation steps in the attenuator mentioned above, with fractional steps, a series of attenuators with increments of 0.1 db was developed. These are available in 50, 75, and 90 ohms impedance.

MODEL NO.	1/432	1/442	1/452
IMPEDANCE (OHMS)	50	75	90
FREQ. RANGE	DC - .5GHz	DC - .5GHz	DC - .5GHz
ATTENUATION RANGE	0 - 22.1	0 - 22.1	0 - 22.1
ATTENUATION STEPS	0.1	0.1	0.1
OVERALL ACCURACY (+-DB)	Steps - 0.1 to 0.5 0.05dB/step Steps - 1 to 10 0.2dB/step DC to 500MHz	5%	DC - 100MHz - 5% 100 - 500MHz - 10%
INSERTION LOSS (DB)	DC - 250MHz - 0.2 250 - 500MHz - 0.2	DC - 250MHz - 0.1 250 - 500MHz - 0.2	DC - 250MHz - 0.1 250 - 500MHz - 0.2
MAXIMUM VSWR	DC - 250MHz 1.2:1 250 - 500MHz 1.2:1	DC - 250MHz 1.2:1 250 - 500MHz 1.4:1	DC - 250MHz - 1.4:1 250 - 500MHz - 1.5:1
POWER (WATTS)	1	0.5	0.5
CONNECTORS	BNC	BNC	BNC
CONTROLS	Toggle	Toggle	Toggle
DIMENSIONS	2 x 9½ x 2 ins	2 x 9½ x 2 ins	2 x 9½ x 2 ins
WEIGHT	2 lbs	2 lbs	2 lbs

MODELS: 460 470 437 447

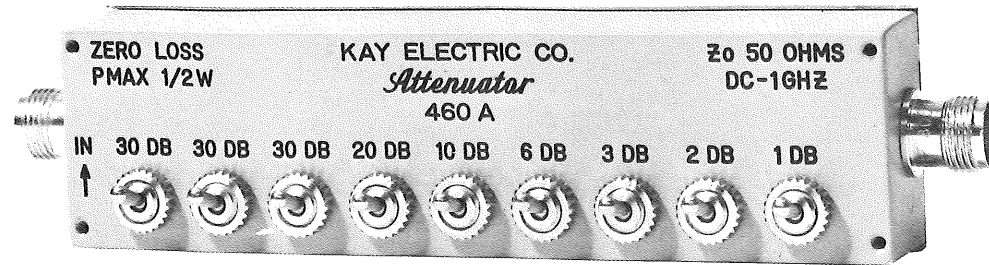

9 STEP MINIATURE IN-LINE 0-132 dB in 1 dB steps
 0-102.5 db in 0.5 dB steps

This compact series of attenuators has been designed primarily for panel mount situations. They measure 1¼x6¼x7.

MODEL NO.	460	470	437	447
IMPEDANCE (OHMS)	50	75	50	75
FREQ. RANGE	DC - 1GHz	DC - 1GHz	DC - 1GHz	DC - 1GHz
ATTENUATION RANGE	0 - 132	0 - 132	0 - 102.5	0 - 102.5
ATTENUATION STEPS	1.0	1.0	0.5	0.5
OVERALL ACCURACY (+-DB)	DC - 250MHz 0.5 250 - 500MHz 1.0 500 - 1000MHz 1.5	DC - 250MHz 1.0 250 - 500MHz 1.5 500 - 1000MHz 2.0	DC - 250MHz 0.5 250 - 500MHz 1.0 500 - 1000MHz 1.5	DC - 250MHz 1.0 250 - 500MHz 1.5 500 - 1000MHz 2.0
INSERTION LOSS (DB)	DC - 250MHz 0.25 250 - 500MHz 0.35 500 - 1000MHz 0.7	DC - 250MHz 0.1 250 - 500MHz 0.2 500 - 1000MHz 0.4	DC - 250MHz 0.25 250 - 500MHz 0.35 500 - 1000MHz 0.7	DC - 250MHz 0.1 250 - 500MHz 0.2 500 - 1000MHz 0.4
MAXIMUM VSWR	DC - 250MHz 1.2:1 250 - 500MHz 1.2:1 500 - 1000MHz 1.4:1	DC - 250MHz 1.2:1 250 - 500MHz 1.2:1 500 - 1000MHz 1.4:1	DC - 250MHz 1.2:1 250 - 500MHz 1.2:1 500 - 1000MHz 1.4:1	DC - 250MHz 1.2:1 250 - 500MHz 1.2:1 500 - 1000MHz 1.4:1
POWER (WATTS)	1	1	1	1
CONNECTORS	TNC	TNC	TNC	TNC
CONTROLS	Toggle	Toggle	Toggle	Toggle
DIMENSIONS	1¼x6¼x7/8 ins.	1¼x6¼x7/8 ins.	1¼x6¼x7/8 ins.	1¼x6¼x7/8 ins.
WEIGHT	8oz	8oz	8oz	8oz

MODELS : 439 449 1/439 1/449

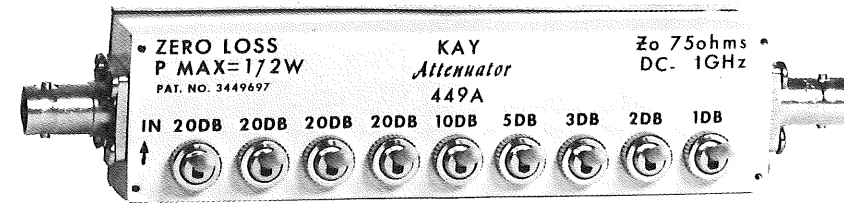

9 STEP MINIATURE IN-LINE 0-101 dB in 1 dB steps
 0-22.1 dB in 0.1 dB steps

MODEL NO.	439	449	1/439	1/449
IMPEDANCE (OHMS)	50	75	50	75
FREQ. RANGE	DC - 1GHz	DC - 1GHz	DC - 1GHz	DC - .5GHz
ATTENUATION RANGE	0 - 101	0 - 101	0 - 22.1	0 - 22.1
ATTENUATION STEPS	1.0	1.0	0.1	0.1
OVERALL ACCURACY (+-DB)	DC - 250MHz 0.5 250 - 500MHz 1.0 500 - 1000MHz 1.5	DC - 250MHz 1.0 250 - 500MHz 1.5 500 - 1000MHz 2.0	DC - 1GHz 0 - 0.5dB steps .05/step 1 - 10dB steps 0.3/step	DC - 500MHz 0 - 0.5dB steps .05/step 1 - 10dB steps 0.3/step
INSERTION LOSS (DB)	DC - 250MHz 0.1 250 - 500MHz 0.2 500 - 1000MHz 0.5	DC - 250MHz 0.1 250 - 500MHz 0.2 500 - 1000MHz 0.4	DC - 250MHz 0.1 250 - 500MHz 0.2 500 - 1000MHz 0.5	DC - 250MHz 0.1 250 - 500MHz 0.2
MAXIMUM VSWR	DC - 250MHz 1.2:1 250 - 500MHz 1.2:1 500 - 1000MHz 1.4:1	DC - 250MHz 1.2:1 250 - 500MHz 1.2:1 500 - 1000MHz 1.4:1	DC - 250MHz 1.2:1 250 - 500MHz 1.2:1 500 - 1000MHz 1.4:1	DC - 250MHz 1.2:1 250 - 500MHz 1.2:1
POWER (WATTS)	1	1	1	1
CONNECTORS	BNC	BNC	BNC	BNC
CONTROLS	Toggle	Toggle	Toggle	Toggle
DIMENSIONS	1¼ x 6¼ x 7/8 ins.	1¼ x 6¼ x 7/8 ins.	1¼ x 6¼ x 7/8 ins.	1¼ x 6¼ x 7/8 ins.
WEIGHT	8 oz	8 oz	8 oz	8 oz

MODELS: 438 448



6 STEP MINIATURE IN-LINE

0-41 dB in 1 dB steps

MODEL NO.	438	448		
IMPEDANCE (OHMS)	50	75		
FREQ. RANGE	DC-1GHz	DC-1 GHz		
ATTENUATION RANGE	0-41	0-41		
ATTENUATION STEPS	1.0	1.0		
OVERALL ACCURACY (±)	DC-250 MHz 0.5 250-500MHz 1.0 500-1000 MHz 1.5	DC-250 MHz 0.5 250-500 MHz 1.0 500-1000 MHz 1.0		
INSERTION LOSS (DB)	DC-250 MHz 0.1 250-500 MHz 1.0 500-1000 MHz 0.5	DC-250 MHz 0.1 250-500 MHz 0.2 500-1000 MHz 0.4		
MAXIMUM VSWR	DC-250 MHz 1.2 250-500 MHz 1.2 500-1000 MHz 1.4	DC-250 MHz 1.2 250-500 MHz 1.2 500-1000 MHz 1.4		
POWER (WATTS)	1	1		
CONNECTORS	BNC	BNC		
CONTROLS	Toggle	Toggle		
DIMENSIONS	1¼ X 5 X 7/8	1¼ X 5 X 7/8		
WEIGHT	8 oz.	8 oz.		

SECTION III

MAINTENANCE

3.1 INTRODUCTION

Because the attenuator is basically a simple instrument, there are relatively few things that can go wrong with it in the field. When there are difficulties, they can normally be expected to fall into one of these groups:

1. Sustained application of excessive power to the input circuits may result in burnt resistors and sometimes switches. Damage of this type is not always limited to the input stage, but may be found anywhere in the attenuator, depending on the attenuation reading at the time of exposure.
2. After a considerable amount of use, the connector contact may become worn, introducing resistance and capacitances into the circuit which give erroneous readings. This usually occurs after a large number of operations. This type of problem is limited to the rotary attenuators.
3. Although these attenuators utilize precious metal contacts, a prolonged period (a few months) of storage time during which the attenuators are left completely idle may result in an oxidation build-up on the contacts.

Problems of the type described in category three are solved simply by operating each switch a few times. Category one and two problems require nothing more than the replacement of a switch, connector, or resistor. Particular problems related to these replacements are covered in the Mechanical Assembly Information section of the particular type of attenuator.

A few methods of testing the Kay attenuators by substitution methods, which can be performed with the equipment found in most electronic laboratories, are given in this section. Anyone desiring additional information is referred to "Instrument Calibration Procedure GA-10, Signal Source Attenuation by Parallel I-F Substitution." Naval Air Systems Command Publication navair 17-20GA-10.

Section 3.3 includes material on the troubleshooting of attenuators with sweep techniques. Many attenuator troubles can be quickly and easily located by the use of sweep techniques.

3.2 TEST PROCEDURE

A. Equipment required

To check out any of the Kay attenuators, it is necessary to have a signal generator that covers the range of the attenuator, an attenuator known to be operating properly (for quick checks, the attenuator may be checked against itself, as described later), and a power meter. The power meter available may not cover the frequency range of the attenuator being tested, and in this case the measurements will have to be made up to the frequency range of the power meter, assume that, if the attenuator operates properly over the lower range, the upper frequency will be all right as well. In most cases, this assumption will be a valid one. Another difficulty with using this type of measurement is that the attenuators with steps exceeding 40 db will not be measurable.

B. Equipment Interconnection

Interconnect the equipment as shown in Figure 3.1. Make sure that all cables and connectors are of the proper impedance, otherwise errors will be introduced through reflections due to mismatch. The signal generator and power meter impedances should either be high or match the impedance of the attenuator. The attenuator used as a standard must be equal in impedance to the attenuator being tested.

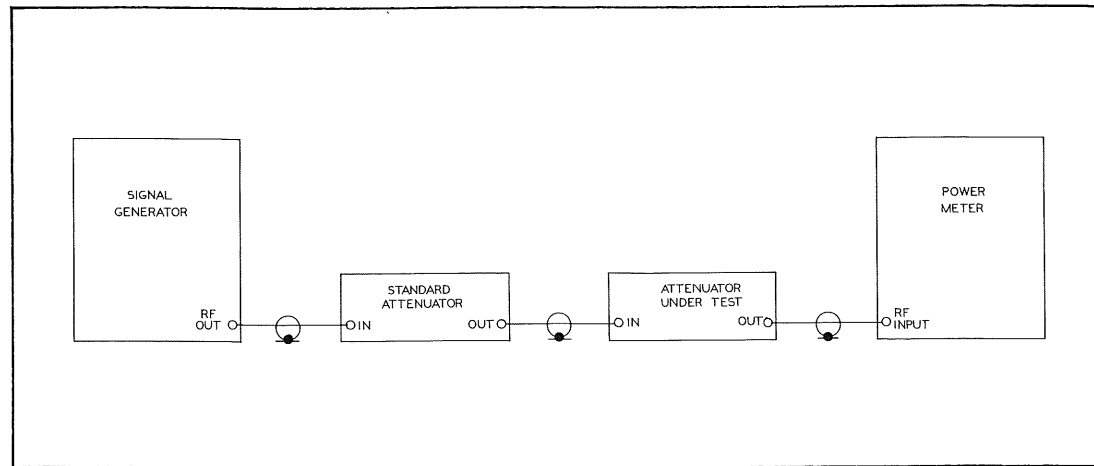

FIG. 3.1 INTERCONNECTIONS FOR CHECKING ATTENUATORS

C. Procedure

Set the signal generator at a comparatively low frequency, such as 70 MHz. Check each attenuation step of the attenuator being tested against the attenuator used as a standard or the meter reading of the power meter. Usually the use of a power meter is less desirable as it requires an accurate meter scale on the power meter.

The generator frequency is increased in steps, and the attenuation checked at each step.

If a standard attenuator is not available, and it is not desired to use the readings of the power meter as an absolute check, the attenuator may be checked against itself. Thus, 30 db step may be checked against a 10 and a 20 db step; a 10 db against a 5, 3, and 2 db step, and so on. This procedure is helpful when quick checks are needed, but it is generally less accurate than the other two procedures mentioned.

3.3 CHECKING ATTENUATORS BY SWEEP METHODS

Sweep techniques can often point out the exact component causing trouble, where as other techniques usually indicate only approximately where the trouble is likely to be found.

This is particularly true with the in-line and rotary-type attenuators. It can also be helpful in locating difficulties with the rotary attenuators. When there is trouble with these attenuators, it is usually in the connector contacts.

Because some of the problems described in this section can be indications of more than one problem, it is advisable to read through the entire section before any attempt is made to replace components.

Almost all difficulties with the in-line or rotary-style type attenuators can eventually be traced to a malfunctioning resistor. Most of the time, a damaged resistor will show up readily in a visual check as a badly burned or broken component. There are times, however, when visual check is not enough.

The resistors in the attenuator will sometimes appear to be normal in a visual check but can still cause difficulty in the attenuator. Such things as chipped ends that may be hidden by the end caps, loose end caps, and hairline cracks in the body of the resistor often do not show up in a visual or ohmmeter check. A quick check using sweep techniques will often locate these hidden problems.

Interconnect the equipment as shown in Figure 3.2. Please review the precautions listed in Section 1.4.

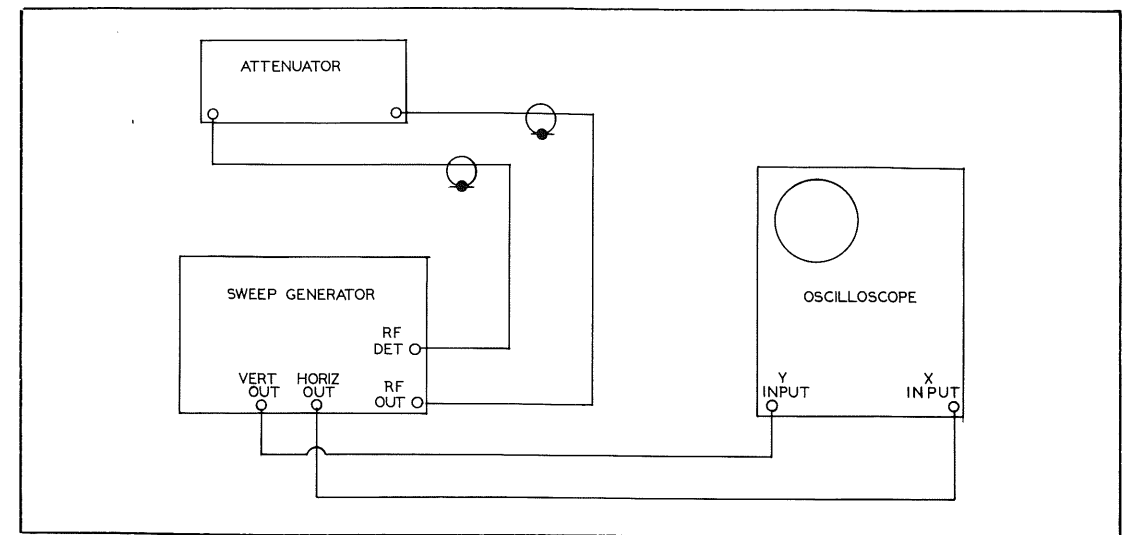

FIG. 3.2 INTERCONNECTION DIAGRAM FOR CHECKING ATTENUATORS BY SWEEP METHOD.

Most Kay attenuators utilize a "PI" resistance network, each pad consisting of three resistors, one series resistor and two shunt resistors, as shown in Figure 3.3. In addition to these three components, there are three or four other components, a resistor and capacitor in the series section, and two capacitors in the shunt section, which affect the high frequency response.

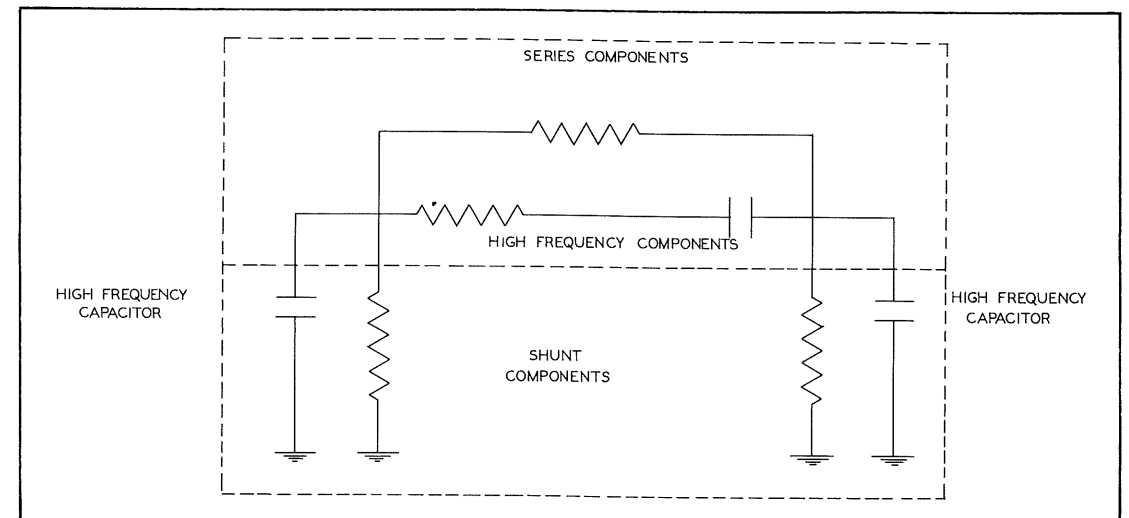

FIG. 3.3 SCHEMATIC OF PI SECTION ATTENUATOR PAD.

An attenuator that is functioning properly will give an essentially flat response curve, as shown in Figure 3.4(a). If the series resistor has increased in value, the response curve will tend to show a positive slope, as shown in Figure 3.4(b). If one of the shunt resistors is open or high in value, the response will have a negative slope as shown in Figure 3.4(c).

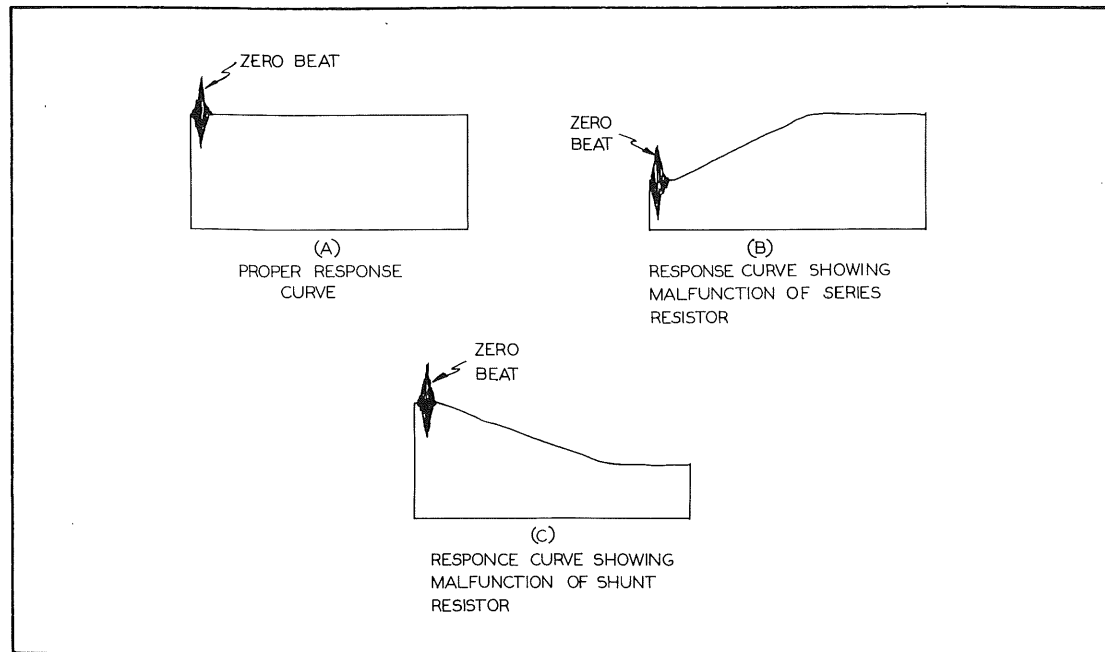

FIG. 3.4 SCOPE TRACES SHOWING ATTENUATOR MALFUNCTIONS AT LOW FREQUENCIES.

If any of the r-c networks in the high frequency compensation circuit of the attenuator are defective, the low frequency portion of the response curve (below approximately 250 MHz) will be unaffected. If, at the upper end of the response curve, the attenuation appears to increase (response curve amplitude drops) the trouble will most likely be located in the series network. If attenuation decreases at high frequencies, the difficulty is most likely to be in the shunt capacitors.

If the difficulty is in the switch itself, any one or more of the problems mentioned above may appear. Here are a few comments which may help to determine whether or not the difficulty is in the switch:

1. The capacitors seldom go bad.
2. The switch seldom goes bad, usually it is a resistor causing the problems.
3. The switch is the component which will sometimes give an indication of more than one problem.
4. Prodding the particular components in question, or wiggling the bat handle of the switch while observing the scope trace should help identify the malfunctioning component.

Most of the problems concerned with the rotary attenuators are traceable to faulty spring contacts on the connectors. Faulty contacts can show up as any of the problems mentioned above, and they may even show up on only one or two positions, leading the technician to think the problem is in those stages rather than the connector. There is one simple way of checking the connector contacts. With the connector out of the attenuator, place the blade of a small screw driver in the open space between the two halves of the spring contacts, just below the closure. Gently push the screw driver blade up through the closure point so that the contacts are forced open and then removed to allow to snap back. If the two halves of the contact do return and are touching each other after this operation, the spring contacts are probably ok. There are other difficulties which may show up, such as poor contact of the ground strap, or poor connection between the spring contact and the connector itself, but problems are not as difficult to locate.

SECTION IV PARTS AND SCHEMATICS

4.1 INTRODUCTION

In this section we cover the information necessary for part identification and procurement. It is provided for situations where return of the attenuator for repair or full step replacement is not possible or practical.

NOTE

All Kay attenuators, especially rotary and sliding block models, should be returned to the factory when repair or recalibration is needed. This being due to the precision electrical and physical tolerances involved in their make up.

We recommend full step replacement as an alternative to the replacement of individual step components.

Prewired replacement steps are available for all Kay Elemetrics' standard in-line attenuators from our factory parts department.

A Parts order form is included at the end of this section.

4.2 PART IDENTIFICATION

As mentioned in the maintenance section, most Kay attenuator steps utilize a Pi resistance network. This network is shown in Figure 4.1. Its shunt and series resistor values are dependent upon the step attenuation level.

The asterisked components provide the step's high frequency compensation and their values will vary. (These components are custom selected at the factory).

Chart 4.1 provides the values for the shunt and series resistors in all Kay Elemetrics' standard step configurations. The values for the high frequency compensation components must be taken from the actual step undergoing repair.

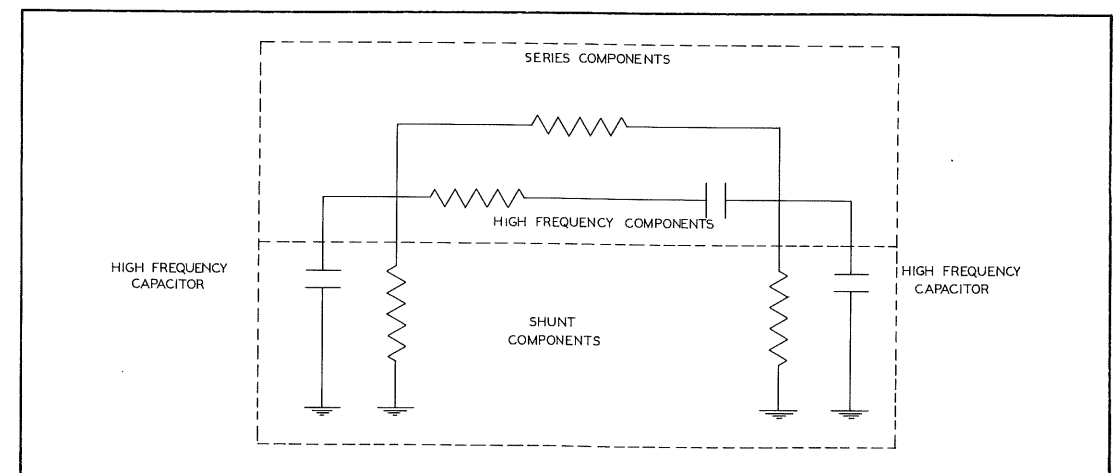

FIG. 4.1 SCHEMATIC OF PI SECTION ATTENUATOR PAD.

STEP (DB)	50 OHM		75 OHM		NOTES
	SERIES	SHUNT	SERIES	SHUNT	
.1	-	4340	-	12950	50 OHM IN-LINE, SHUNTS ONLY
.2	1.151	4340	1.727	6510	
.3	1.727	2895	2.590	4343	
.4	2.305	2173	3.458	3260	
.5	2.87	1745	4.305	2620	
.6	3.455	1449	5.183	2172	
.7	4.035	1242	6.053	1863	
.8	4.605	1086	6.908	1629	
.9	5.185	967	7.778	1450	
1.0	5.81	863	8.72	1305	
2	11.62	436	17.4	654	
3	17.6	292	26.45	438	
4	23.8	221	35.7	332	
5	30.4	178	45.7	268	
6	37.4	150	56.1	226	
7	44.8	131	67.2	1965	
8	52.8	116	79.2	174	
9	61.5	105	92.3	158	
10	71.17	96.15	106.76	144	
20	248	61.1	372	916	
30	790	53.2	1185	79.9	
35	1407	51.8	2111	77.7	
20	248	122.2	-	-	UNITS RATED 1w REQUIRE DUAL SHUNTS.
30	790	106.5	-	-	

ALL RESISTORS ARE CARBON OR METAL FILM 1%, NONINDUCTIVE,
LOW CAPACITY TYPES SHUNTS 1/4w, SERIES .1-3DB, 20-35DB-1/8w
20-35DB-1/4w

4.3 SCHEMATICS

Due to the many different models and their basic similarity in design, individual schematics of all of the attenuators covered in this manual will not be shown. Reference should be made to the basic step schematic in figure 4.1 and the component value chart (4.1).

In figures 4.2 and 4.3 we show typical schematics of a 9 step in line attenuator and a 10 step rotary attenuator. These are given as an aid to developing an overall image of an attenuator's total electrical configuration.

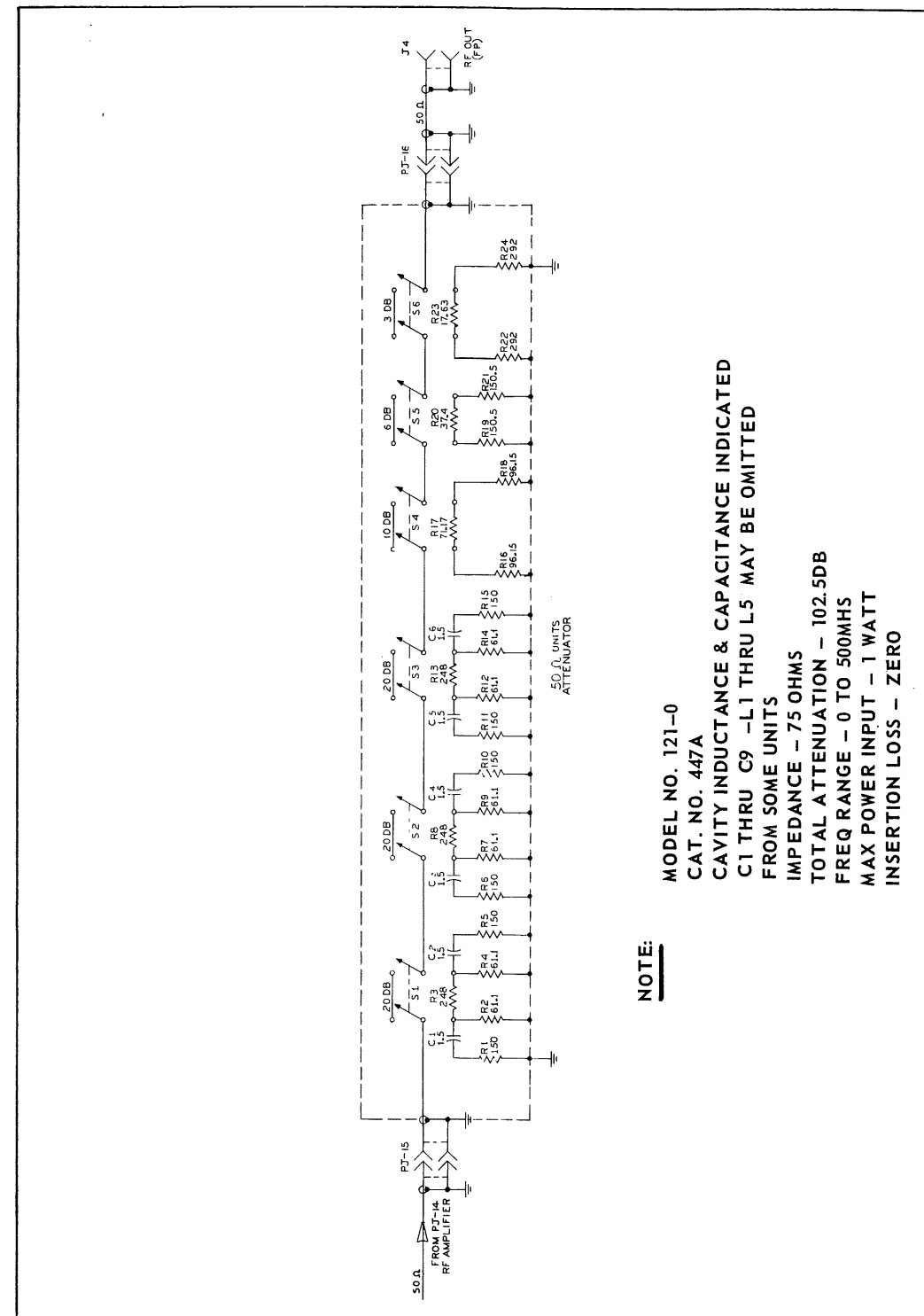

FIG. 4.2 TYPICAL IN-LINE SCHEMATIC

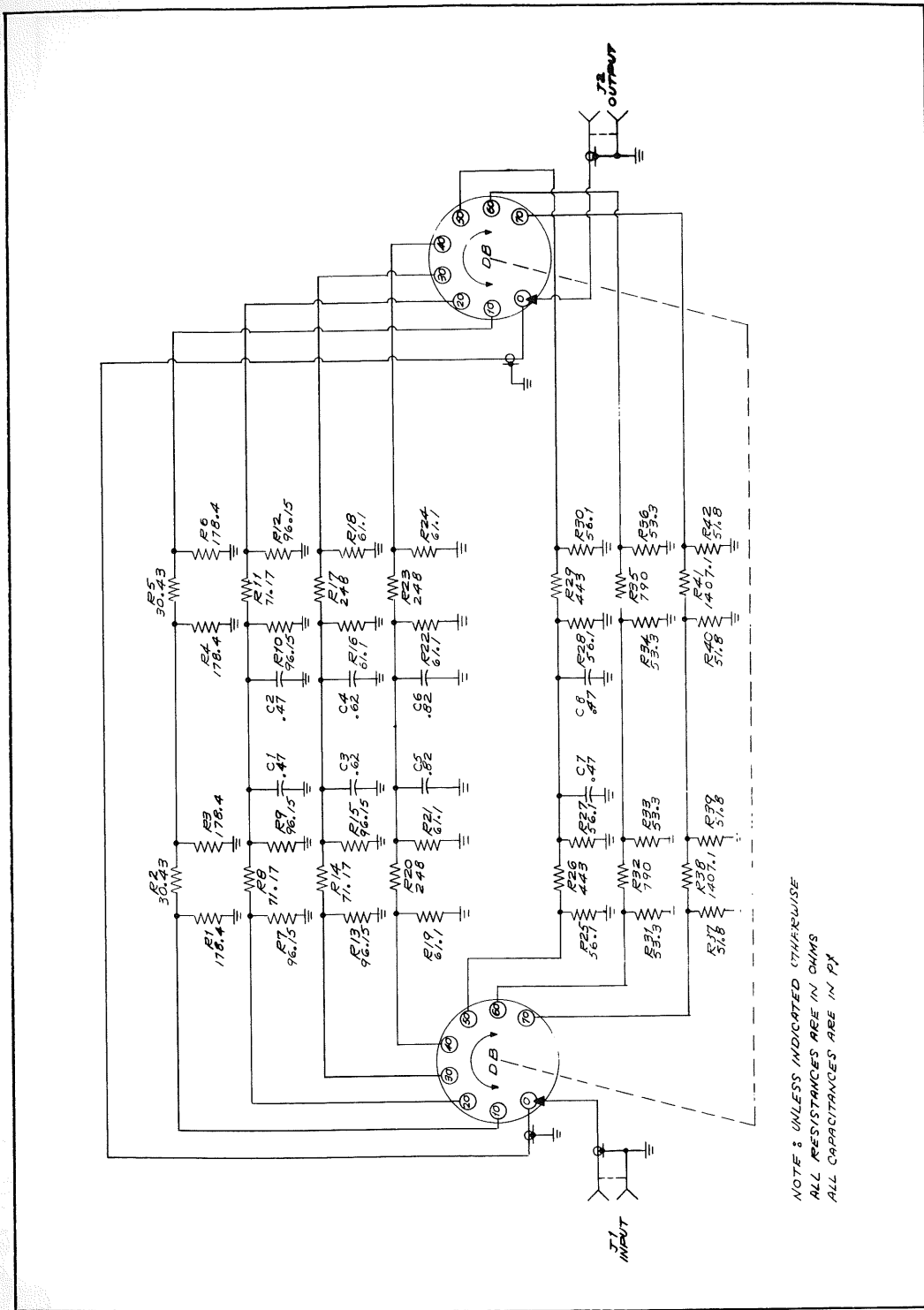

FIG. 4.3 TYPICAL ROTARY SCHEMATIC

PARTS ORDER SHEET

COMPANY _____

ADDRESS _____

INSTRUMENT CATALOG NO. _____

INSTRUMENT SERIAL NO. _____

SCHEMATIC REFERENCE NO. _____

KAY PART NO. _____ IMPEDANCE _____

DB STEP _____

PART DESCRIPTION:

REMARKS:

PARTS ORDER SHEET

COMPANY _____

ADDRESS _____

INSTRUMENT CATALOG NO. _____

INSTRUMENT SERIAL NO. _____

SCHEMATIC REFERENCE NO. _____

KAY PART NO. _____ IMPEDANCE _____

DB STEP _____

PART DESCRIPTION:

REMARKS: